

BAUER BG 36

Rotary Drilling Rig

Base Carrier BT 90

ValueLine



Experience for you!

“Technology market leader and pioneer for innovations, at the same time down-to-earth with responsibility towards society and environment - that’s our goal.”

Prof. Dr. Sebastian Bauer

We could start by telling you about Sebastian Bauer, who founded a copper forge in the German town of Schrobenhausen some 200 years ago. We could then move on to how his workshop prospered and developed to a leading construction company for specialist foundation engineering. The story would continue to the mid 20th century, when innovation and the drive for perfection prompted Bauer to develop and build their own high-quality and high-performance machinery.

And it still wouldn’t end in the 21st century, Bauer now family-run in the seventh generation and meanwhile a globally operating group with more than 100 branches and subsidiaries operating in the fields of special foundation engineering (Bauer Spezialtiefbau), in manufacturing of foundation equipment (Bauer Maschinen) and focusing on products and services in the fields of water, energy, mineral resources and environmental technology (Bauer Resources).

But we think what really matters about us and to our customers is this: We are a strong partner with face and values, we are down to earth, and we are dedicated to perfection in everything we touch.



1790

Foundation as a copper forge in Schrobenhausen, Germany



1928

Well drilling in Bavaria, Germany

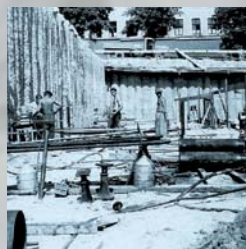

1958

Invention of the ground anchor by Dr.-Ing. K.H. Bauer



1976

First hydraulic rotary drill rig BAUER BG 7



1984

First diaphragm wall trench cutter BC 30

More than machines: Competent consulting

*Quality is not an act,
it is a habit.*

Of the thousands of machines Bauer Maschinen has built since production started in the 1970's with the first rotary drill rig BG 7, many of them are still in operation all over the world – in Siberia as well as in the desert. State of the art technology developed end-to-end by our inhouse engineers and full machine tests prior to delivery are one side of the coin. Bauer Maschinen can serve any customer need with the most comprehensive product portfolio.

The other side is project-specific consulting by highly trained experts, with a focus on your special requirements.

- **Quality and experience in specialist foundation engineering**
- **Global operation – local contacts in over 70 countries**
- **Reliability in technology, service**
- **Customized solutions**
- **On-site support over entire machine service life**



1980's

Start of international equipment sales



2001

Bauer Maschinen established as independent company within the Bauer Group



2006

Stock market launch of BAUER AG, directed by Prof. Thomas Bauer



2011

Introduction of BG ValueLine and BG PremiumLine



2014

With EEP Bauer sets new standards for efficiency

The BG ValueLine

*Perfection is achieved
when there is nothing left to take away.*

You are drilling uncased deep boreholes stabilized by drilling fluid, or cased boreholes either with installing casings by the rotary drive or by a hydraulic casing oscillator? If Kelly drilling is your task, then the BG ValueLine is your solution. The machines of the ValueLine are specifically adapted to no other purpose than Kelly drilling - and that perfectly.

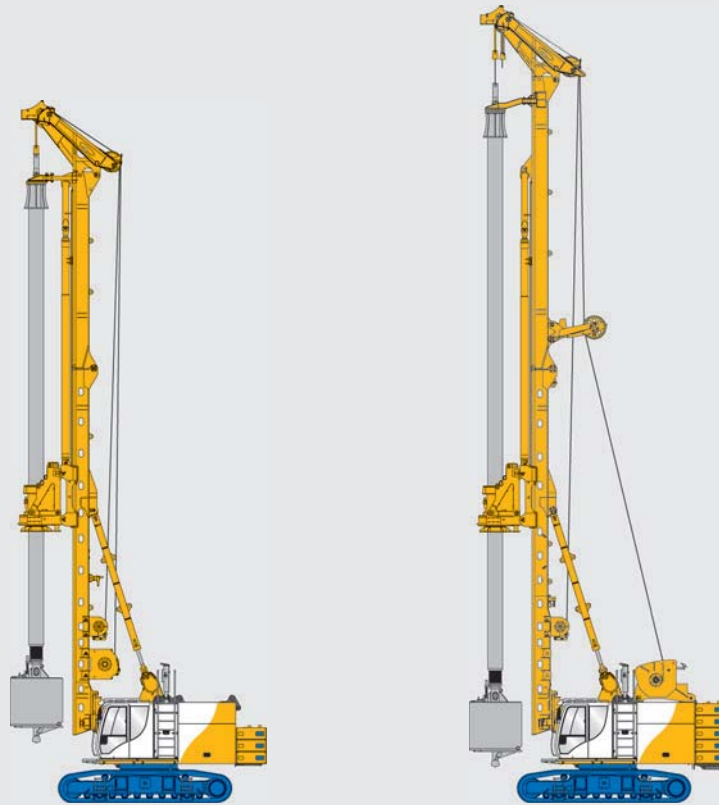

BG 26 BT 70

BG 28 BT 70

	BG 26 BT 70	BG 28 BT 70
Max. drilling diameter	2,500 mm	2,500 mm
Max. drilling depth	77 m	77 m
Torque	264 kNm	280 kNm
Engine power*	280 kW	280 kW
Max. height	25.1 m	25.1 m
Weight w/o drill string	68 t	70 t

* depending on emission standard

- Long mast for more drilling depth
- Large drill axis for big diameters
- Well balanced concept for high productivity and economic operation
- Optimized hydraulic system for high dynamic performance
- Easy handling, easy maintenance
- Variable transport concept



BG 30 BT 80

2,500 mm

87 m

300 kNm

310 kW

26.9 m

91 t

BG 36 BT 90

3,000 mm

115 m

355 kNm

345 kW

33.3 m

127 t

BG 42 BT 110

3,000 mm

115 m

420 kNm

405 kW

33.3 m

140 t

The rotary drilling rig
BG 36 ValueLine BT 90

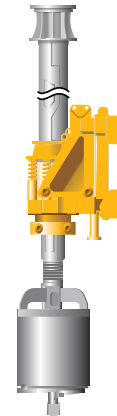

Kelly Drilling

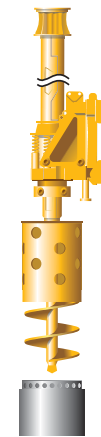

Cased Kelly Drilling

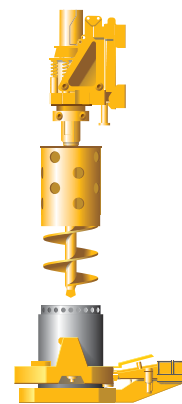

Cased Kelly Drilling
Installation with Oscillator

Rotary drive		KDK 360 K		
Torque (nominal) at 320 bar		355 kNm		
Speed of rotation (max.)		26 rpm		
Mast system				
Effective Crowd force for tool pushing		230 kN		
Effective crowd force for pulling casings		460 kN		
Crowd stroke		8,500 mm		
Mast inclination backward / forward / lateral		15° / 5° / 5°		
Main winch – single layer				
Winch classification		M6 / L3 / T5		
Line pull (1st layer), effective		360 kN		
Rope diameter		36 mm		
Line speed (max.)		63 m/min		
Auxiliary winch				
Line pull (1st layer), effective		100 kN		
Rope diameter		20 mm		
Line speed (max.)		55 m/min		
Base carrier		BT 90		
Engine		Volvo TAD 13	Volvo TAD 13	
Rated output ISO 3046-1		345 kW @ 1,900 rpm	345 kW @ 1,900 rpm	
Engine conforms to			Stage V	
EEC 97/68 EC			Tier 4 final	
EPA/CARB		ORA		
GB20891-2014		Stage III		
Diesel tank / AdBlue tank capacity		700 l / –	700 l / 70 l	
Ambient air temperature (at full power) up to		45 °C		
Sound pressure level in cabin (EN 16228, Annex B)		L _P A 80 dB(A)		
Sound power level (2000/14/EC and EN 16228, Annex B)		L _W A 110 dB(A)		
Undercarriage		UW 115		
Crawler type		B7		
Traction force, effective		730 kN		
Overall width of crawler (retracted / extended)		3,380 mm / 4,780 mm		
Width of track shoes		800 mm		
Applications – Recommended Rig Configurations				
	Allround	Big Drilling	Deep Drilling	Low-Headroom
Drilling axis	1,350 mm	1,550 mm	1,350 mm	1,350 or 1,550 mm
Mast extension	2.3 m	2.3 m	5.4 m	without upper mast
Counterweight	29.4 t	29.4 t	34.3 t	24.5 t
Operating weight *	122 t	122 t	127 t	111 t
Operating height	30.2 m	30.2 m	33.3 m	16.4 m
Max. Kelly bar length ("A")	23.25 m	23.25 m	26.25 m	9.75 m
Max. depth x diameter	60 x 2.5 m	60 x 3.0 m	80 x 2.5 m	19.5 x 3.0 m
	80 x 2.5 m	80 x 3.0 m	92 x 2.0 m	26 x 3.0 m
	100 x 2.0 m	100 x 2.0 m	115 x 1.5 m	32.5 x 3.0 m
Attachment of casing drive adapter	yes	yes	yes	yes
Add-on kit for BV-usage	can be installed	can be installed	can be installed	can be installed
Conversion kit low-headroom	can be used	can be used	can be used	applied

* without Kelly

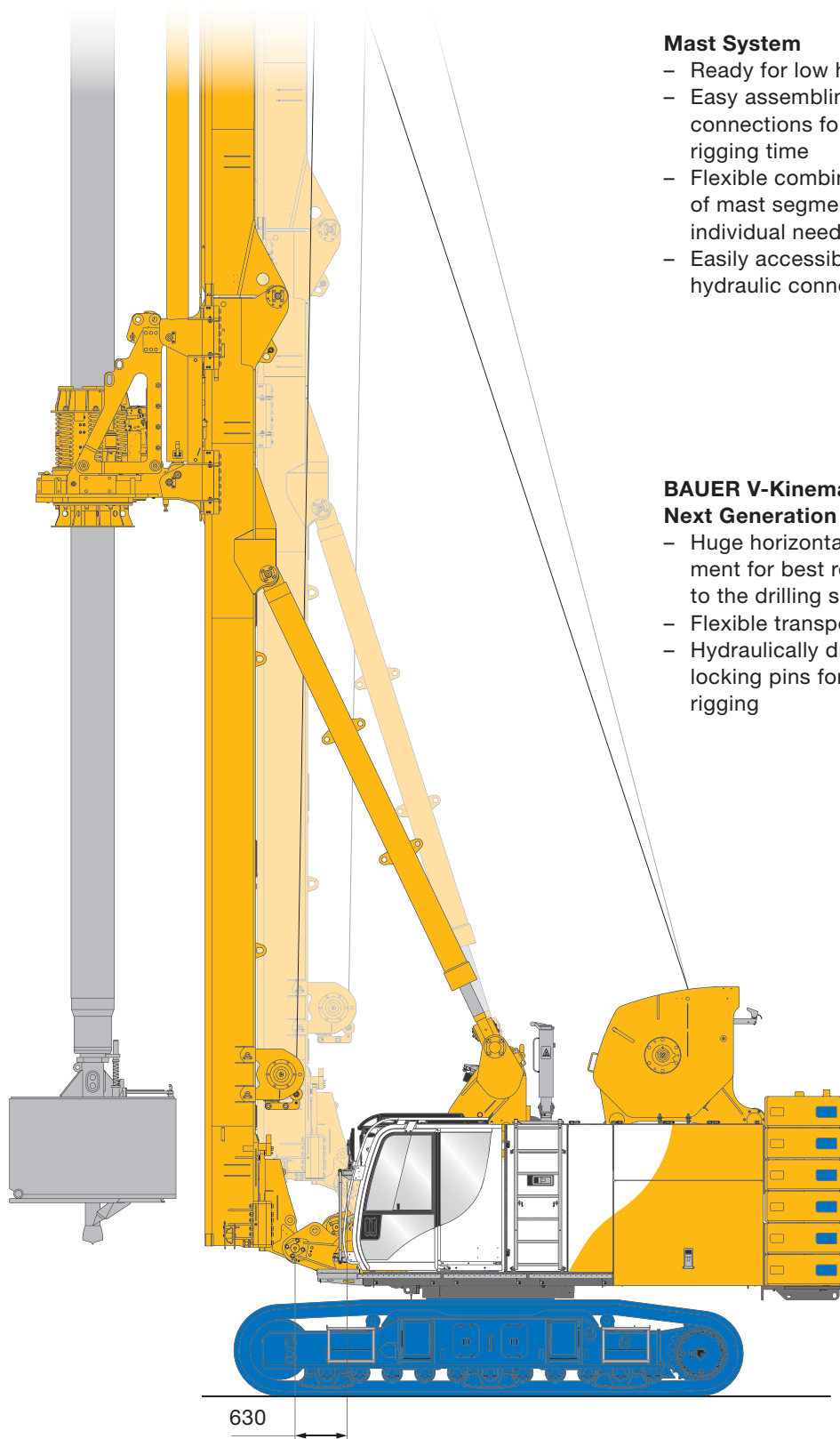

Mast System

- Ready for low head
- Easy assembling connections for fast rigging time
- Flexible combination of mast segments for individual needs
- Easily accessible hydraulic connections

BAUER V-Kinematic – Next Generation

- Huge horizontal movement for best reach to the drilling spot
- Flexible transport system
- Hydraulically driven locking pins for easy rigging

Rotary Head

- very robust rotary head
- Bauer Kelly damping system
- Kelly visualization system

630

The ALL-NEW BT 90

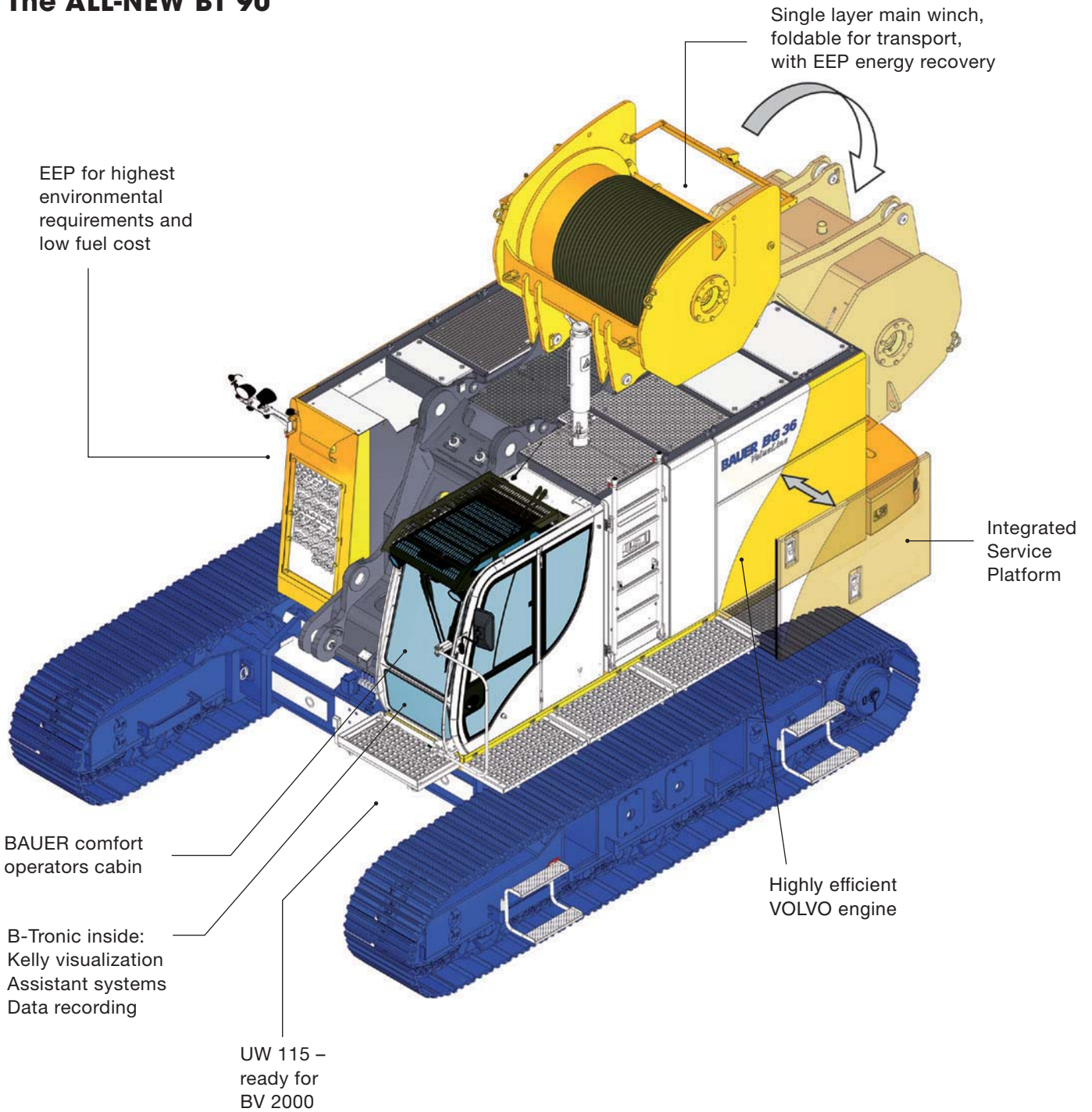

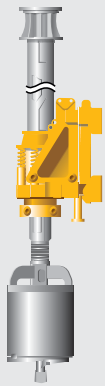

Kelly Drilling

Kelly drilling is the most versatile drilling method. Telescopic Kelly bars (3-fold, 4-fold, 5-fold) can reach a high depth. The quickly exchangeable tools can adapt to the varying soil conditions in the different soil layers. Bauer provides all high quality Kelly bars and high performance drilling tools.

The KDK is normally equipped purely with the trigger plate.



Cased Kelly Drilling

If the soil is not very stable or if there is ground water or if jobsites require it e.g. for secant pile wall, then the BG also can drive the casings.

To do this method, the BG just has to be equipped with

- a cardan joint below the KDK,
- the casing drive adapter for the required diameter. Bauer offers manually or automated locking casing drive adapters.

You flexibly adapt it to the BG only when you need it.

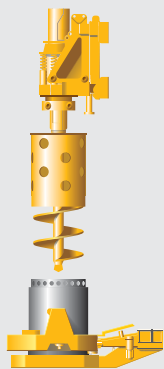

Cased Kelly Drilling with Casing Oscillator (BV)

To drive extremely big diameter casings or do very deep casings, an oscillator (BV) can be attached to the BG.*

The casings are firstly driven by the KDK, and when the KDK comes to the limit, the BV takes over.

To do this method, the BG just has to be equipped with

- a cardan joint below the KDK,
- the casing drive adapter for the required diameter,
- a BV with the correct reduction insert for the required diameter.

You flexibly adapt it to the BG only when you need it.

* The BG has to be pre-equipped for BV operation



One-Stop Shop

We offer the rig itself, components for the different methods as well as Kelly bars and the appropriate drilling tools. Supplying wear parts and providing customer service rounds up the complete system solution for your success.

B-Tronic

The BAUER B-Tronic system allows completion of construction tasks in a reliable and accurate manner, even under extreme operating conditions.

- The high-resolution touchscreen display ensures excellent user-friendliness.
- The display can be optimally adapted to the operating situation and the amount of light present by changing the brightness level, the color scheme and the day/night mode.
- The main parameters such as pump pressure, torque and drilling depths can be viewed at a glance.

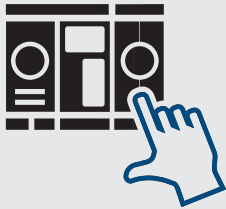

Assist!

- Kelly visualization
- Kelly drilling assistant
- Spoil discharge assistant
- Adaptive Kelly speed assistant (optional)



Operate!

- B-Tronic display
- Remote control for rigging process
- Operators cabin with streamline concept



Manage!

- WEB BGM online portal:
- Fleet management system
 - Fuel consumption recording
 - Production data recording



- Reduction of fuel consumption by up to 30%
- Increased productivity through improved efficiency
- Significantly reduced noise levels
- Tried and proven suitability for practical application
- Optimized parallel operation of main and auxiliary consumers

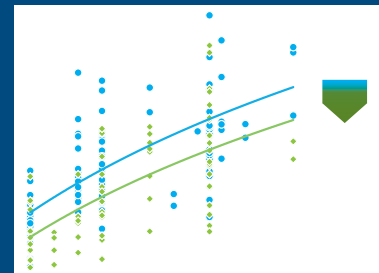

Base Carrier

Standard

- Undercarriage UW 115
- Removable counterweight
- Engine diagnostic system
- Walkway at the side and in front of the cabin, **Fig. A**
- Rear view camera
- Electric refuelling pump
- Multigrade hydraulic oil
- Bauer comfort operator's cab with roof guard (FOPS compliant), **Fig. A**
- On-board lighting set
- Air conditioning system
- Radio with CD, MP3 and USB
- Lashing lugs on crawler units
- Comfort handling package
- Central lubrication system
- Assistance system
- Guard rails on top of upper carriage
- Integrated service platform, **Fig. B**

Optional

- Air compressor 1,000 l/min, 12 bar
- Hydraulic powered electric generator (230 V AC, 13 kW)
- Vise attachment
- Arctic kit
- Cab space heater with automatic timer
- Remote Control Basic for rigging, **Fig. E**
- Foldable guard rails on top of upper carriage
- Hydraulic locking device for support trestle
- Bauer service tool kit
- Quick-release couplings for removable crawler side frames

BG attachment

Standard

- Bauer V-type kinematic system
- Inverted crowd cylinder
- Crowd speed fast and slow mode
- Swivel for main rope
- Pivoted anchor point for main rope and auxiliary rope
- Transport supports for upper and lower mast sections
- Crowd cylinder stroke 8,500 mm
- Drilling axis 1,350 mm
- Mast extension 2.3 m

Optional

- Drilling axis 1,550 mm
- Mast extension 5.4 m
- Upper Kelly guide
- Add-on kit for casing oscillator usage up to BV 2000, **Fig. D**
- Low-headroom package
- Predrill CFA package
- Swivel for auxiliary rope



KDK rotary drive

Standard

- Integrated Kelly damping system
- Wear pads of base sled exchangeable without removal of the rotary drive
- Exchangeable Kelly drive adapter assembly KA 671/470
- Exchangeable Kelly drive keys
- Quick-release couplers on hydraulic hoses
- Transport supports
- Trigger plate
- Lifting sling set for rotary drive

Optional

- Cardanic joint
- Torque multiplier BTM 720 K (torque 500 kNm)

Main winch, Fig. C

Standard

- Hydraulically controlled freewheeling
- Automatic rope tensioning function
- Swivel alignment function
- Depth sensing device on main rope
- Electronic load measuring
- Overload detection system

- Winch drum with special grooving
- Pin connection
- Transparent ring for easy oil check
- Camera for main winch surveillance
- Single layer operation down to 115 m
- Foldable for transport

Measuring and control equipment

Standard

- Bauer B-Tronic incl. integrated diagnostic capability, Fig. F
- Display of fault messages as plain text
- Mast inclination measurement on x/y axis (digital/analog display)
- Automatic vertical alignment of mast
- Optical mast inclination monitoring system
- Spoil discharge assistant
- Hydraulic load sensing on auxiliary winch
- Speed sensing device on KDK
- Hoist limit switch on main and auxiliary winch

Optional

- Remote transmission of rig data (DTR-module)
- Electronic load sensing on auxiliary rope



Performance data

Drill axis	1,350 mm
Counterweight	29.4 t
Mast extension	2.3 m
Operating weight*	122 t
Machine height	30.2 m
Horizontal reach	630 mm
Cylinder stroke	8,500 mm
Max. Kelly bar length ("A")	23.25 m
Max. depth x diameter	80 x 2.5 m
	100 x 2.0 m

* Weight w/o drill string

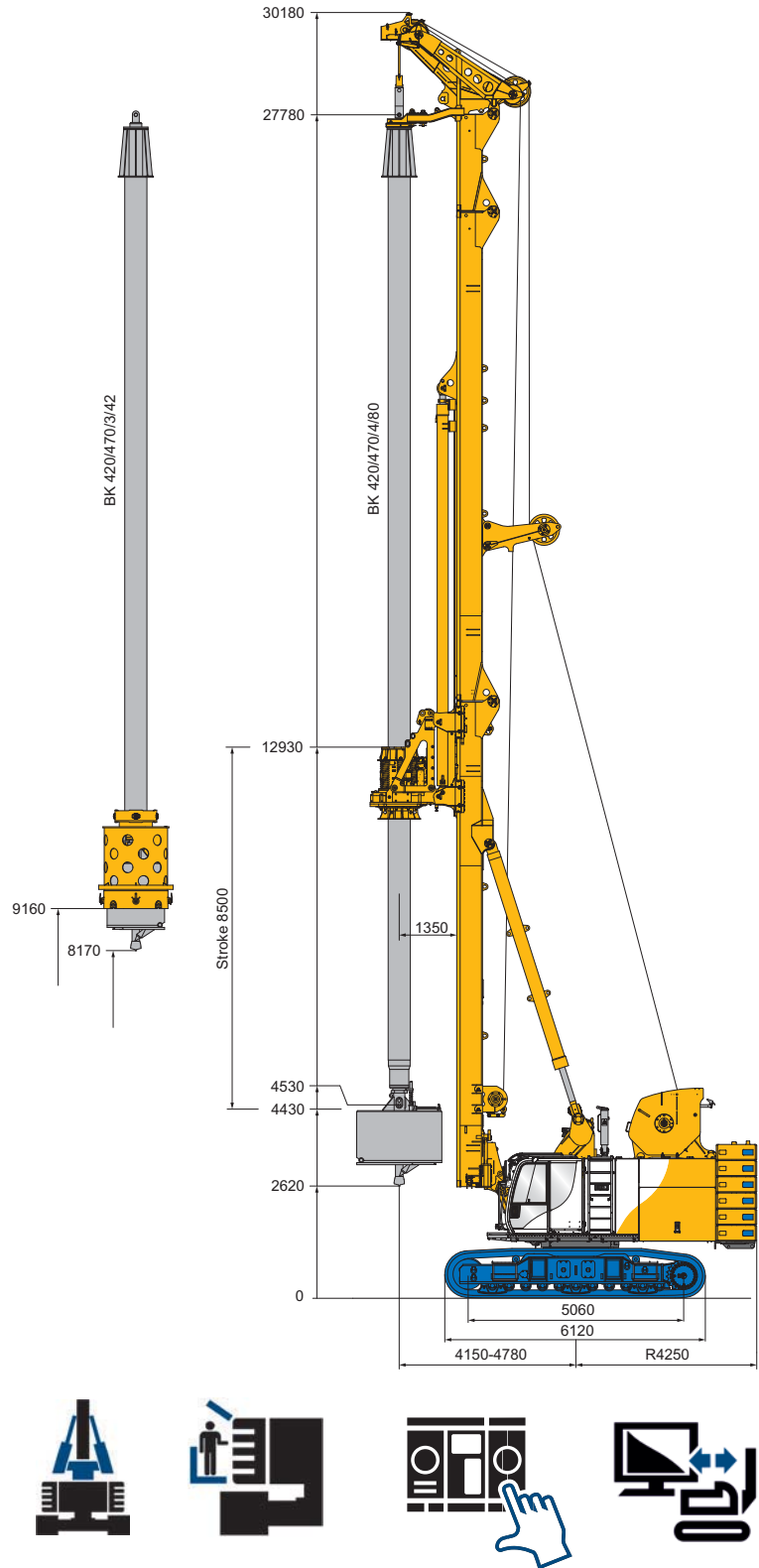
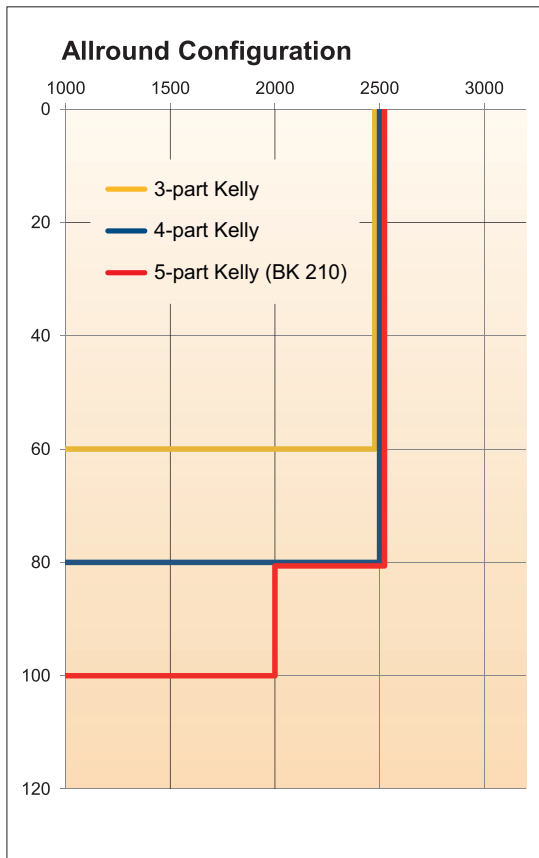

Performance data

Drill axis	1,550 mm
Counterweight	29.4 t
Mast extension	2.3 m
Operating weight*	122 t
Machine height	30.2 m
Horizontal reach	630 mm
Cylinder stroke	8,500 mm
Max. Kelly bar length ("A")	23.25 m
Max. depth x diameter	80 x 3.0 m
	100 x 2.0 m

* Weight w/o drill string

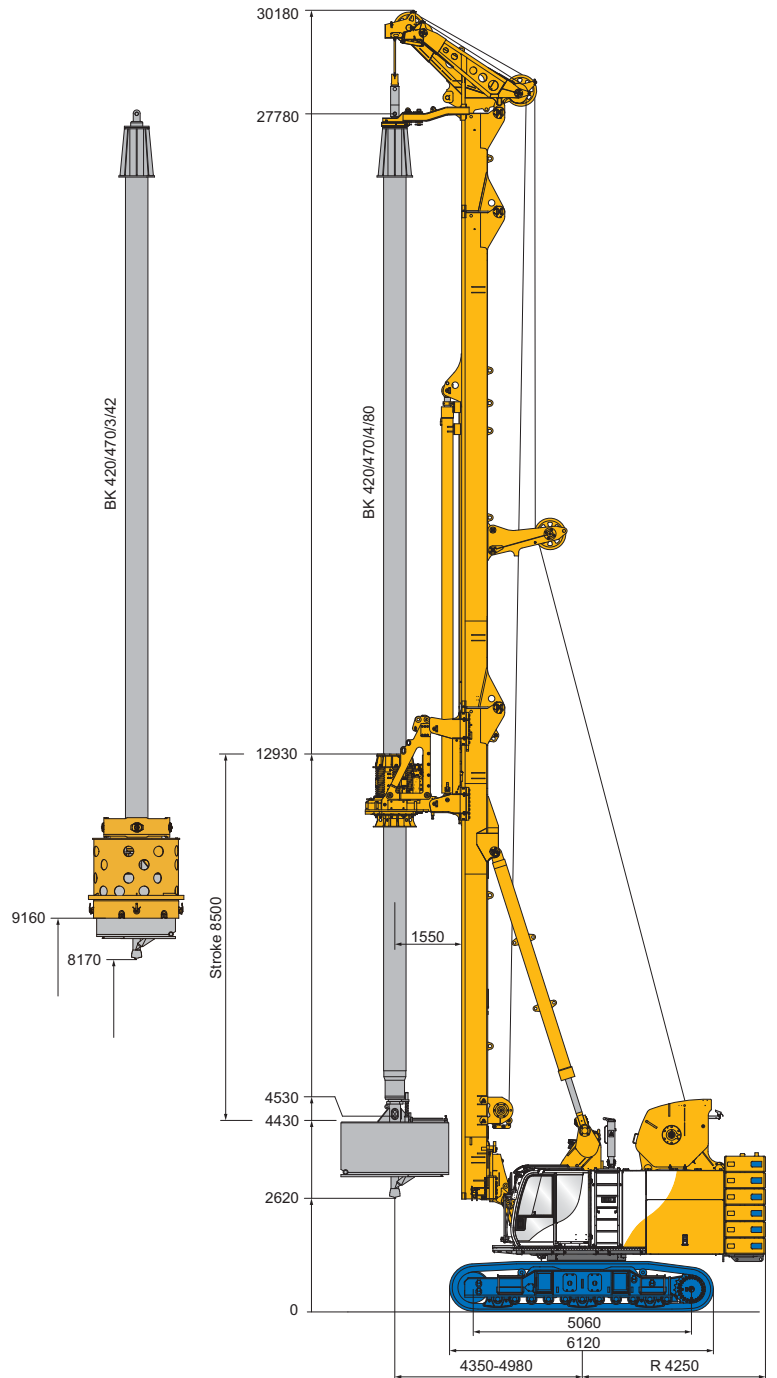
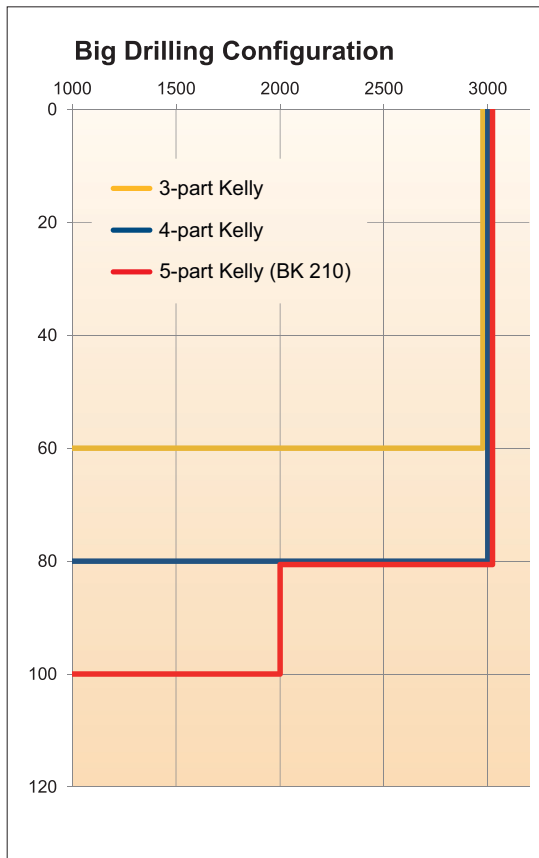

Performance data

Drill axis	1,350 mm
Counterweight	34.3 t
Mast extension	5.4 m
Operating weight*	127 t
Machine height	33.3 m
Horizontal reach	630 mm
Cylinder stroke	8,500 mm
Max. Kelly bar length ("A")	26.25 m
Max. depth x diameter	80 x 2.5 m
	115 x 1.5 m

* Weight w/o drill string

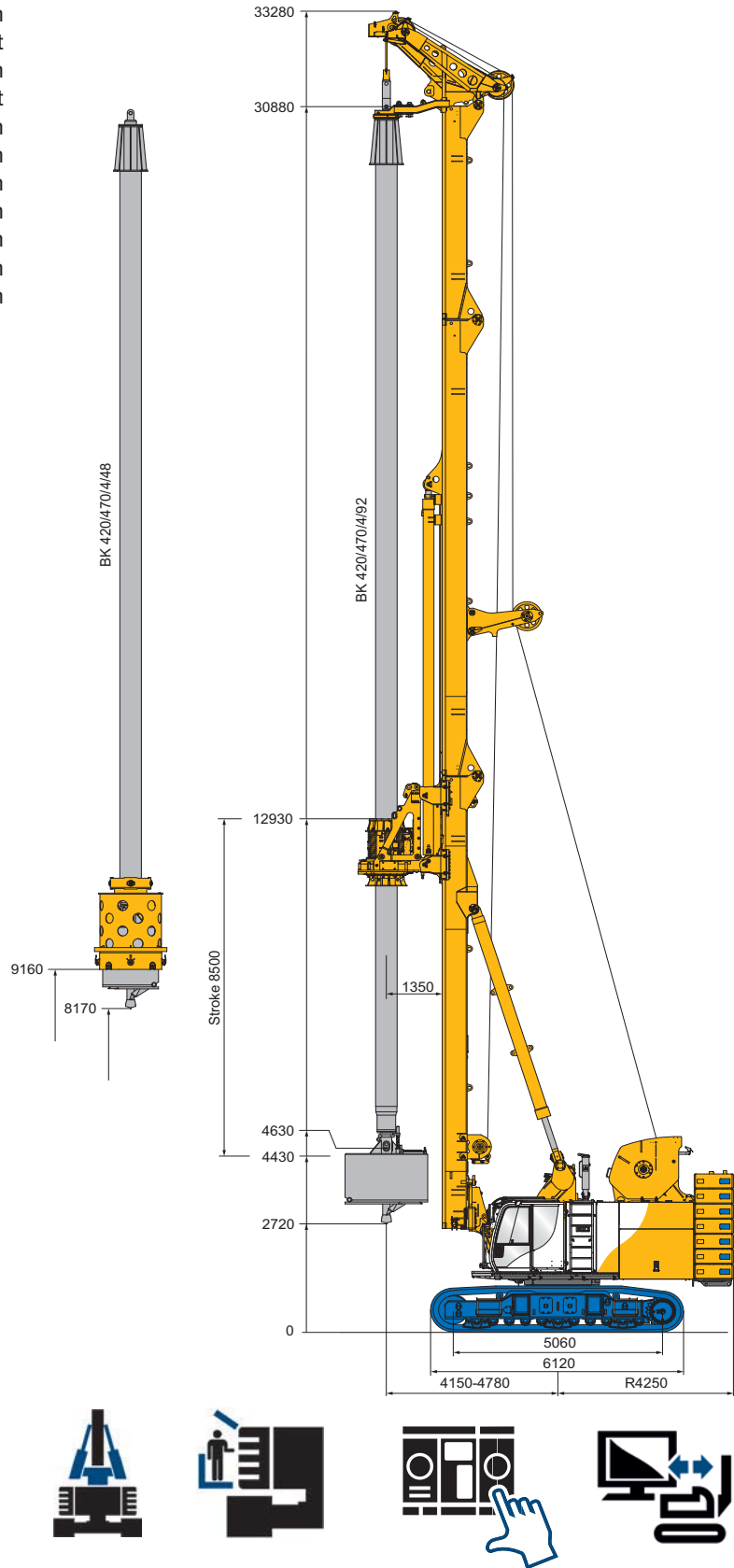
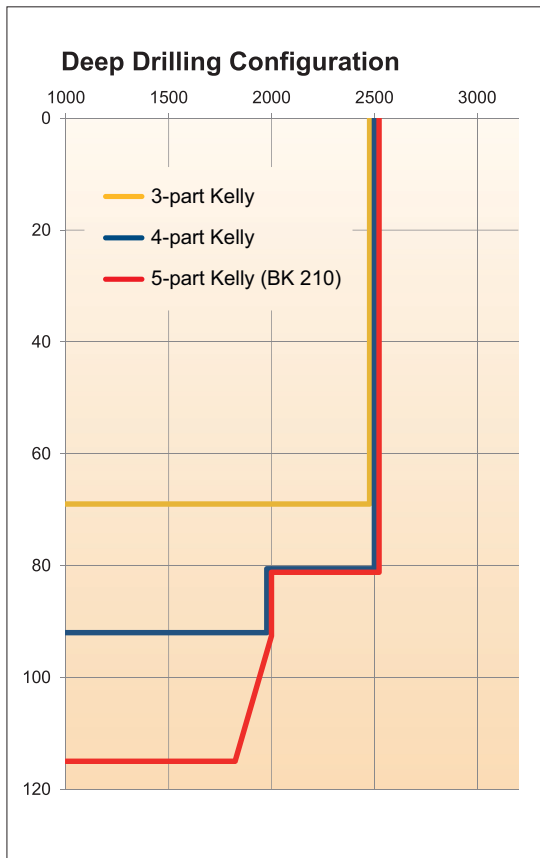

Cased Kelly Drilling with Casing Oscillator (BV)

To enable the BG 36 on BT 90 for BV-usage, an **add-on kit** is available. It consists of:

- Hydraulic installation set
- Software update

The BG 36 on BT 90 can work together with a BV 1500 or BV 2000 having this add-on installed.

Low-headroom Operation

The BG 36 on BT 90 can be converted to low-headroom at any time when the jobsite requires it.

The **conversion kit** consists of:

- low-headroom crowd cylinder
- low-headroom main rope
- low-headroom auxiliary rope

Performance data

Drill axis	1,350 mm or 1,550 mm
Counterweight	24.5 t
Operating weight*	111 t
Machine height	16.4 m
Horizontal reach	630 mm
Cylinder stroke	5,200 mm
Max. Kelly bar length ("A")	9.75 m
Max. depth	3-part Kelly 19.5 m
	4-part Kelly 26 m
	5-part Kelly (BK 210) 32.5 m

* Weight w/o drill string

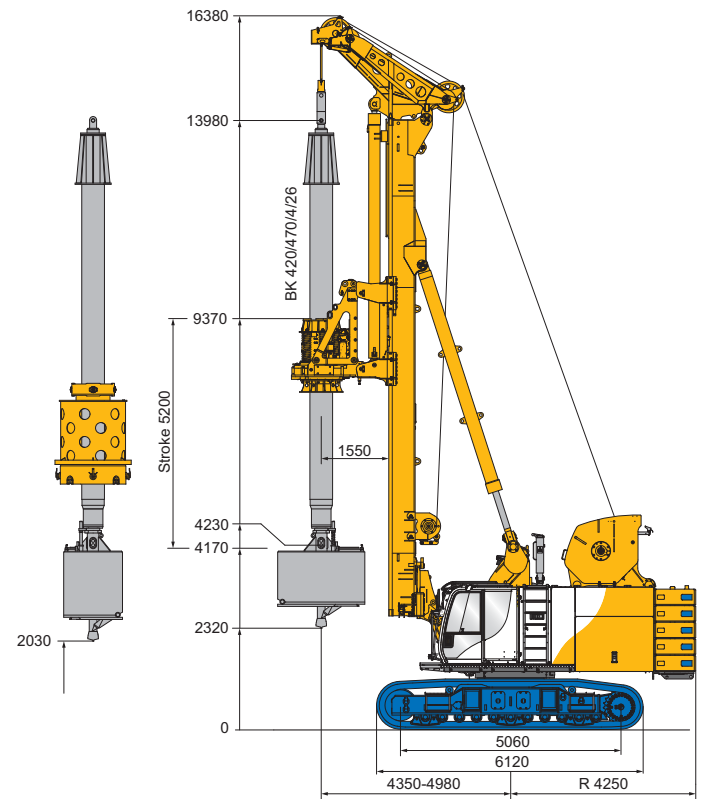
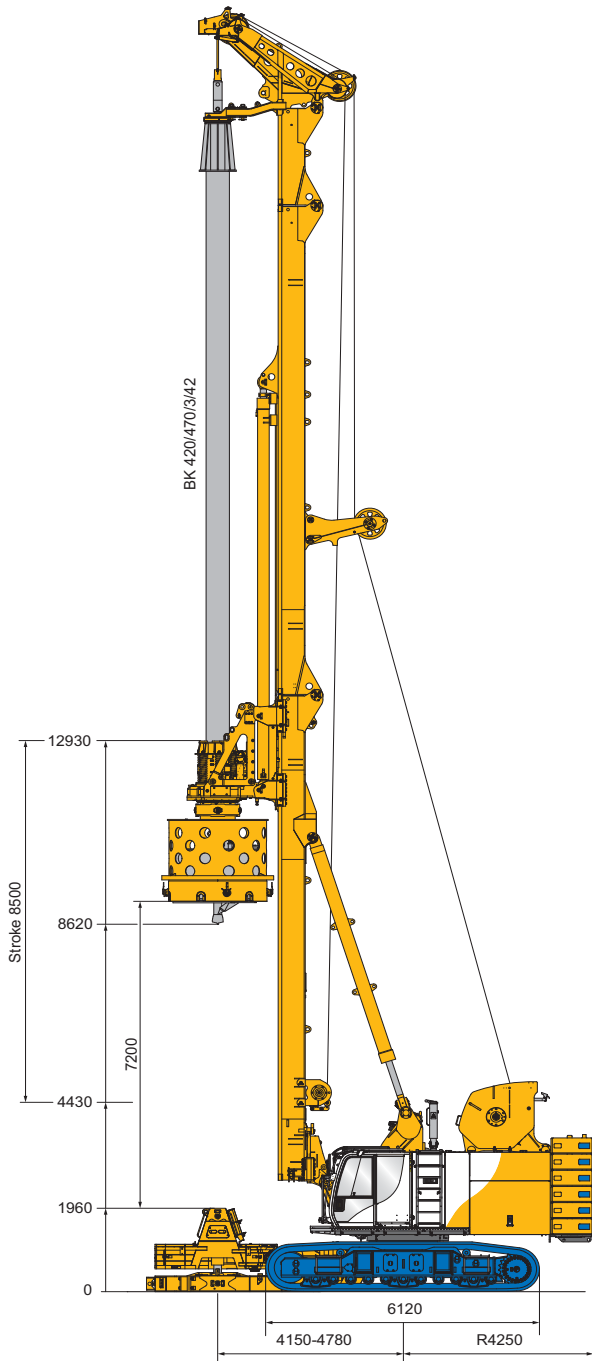

G = Weight
B = Width, overall

Weights shown are approximate values; optional equipment may change the overall weight and dimensions.

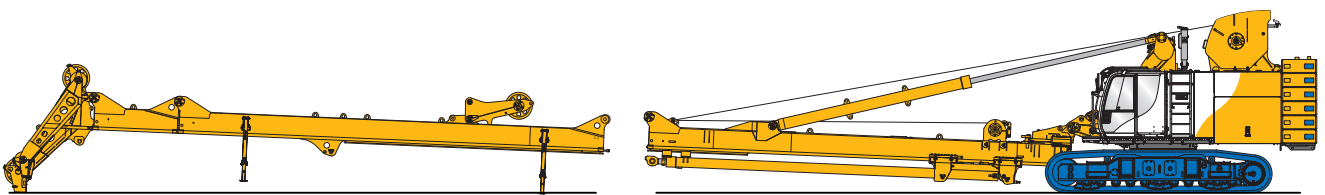
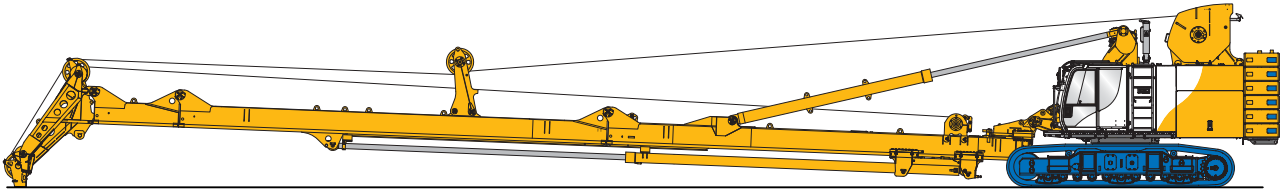

Transport without upper mast section and winch, with 29.4 t counterweight

G = 100.0 t

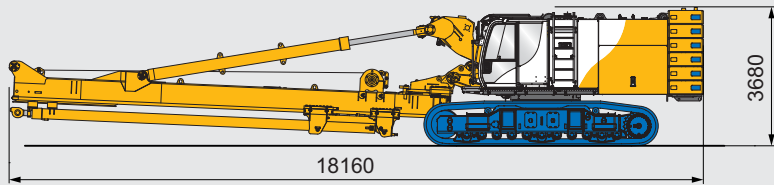
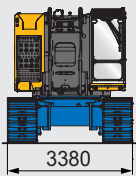

Upper mast section with 2.3 m mast extension and mast head

G = 7.7 t
B = 1,900 mm

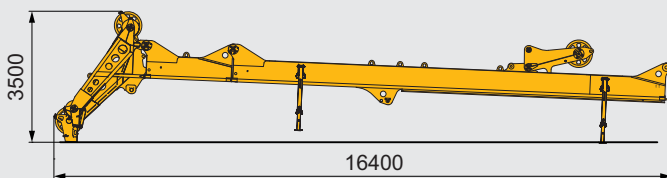

Telescopic transport supports
Mast head tilted

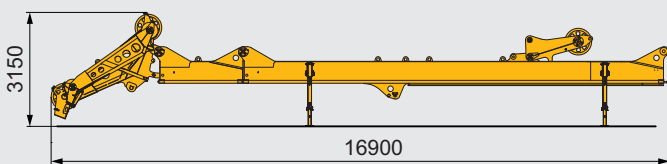

Main winch

G = 7.6 t
B = 2,400 mm

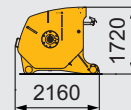

Rotary drive KDK

G = 6.5 t

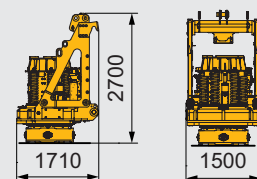

Transport without counterweights

G = 77.0 t

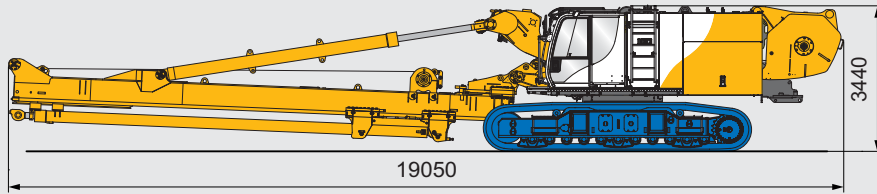

Lower mast section

G = 19.0 t
B = 2,300 mm

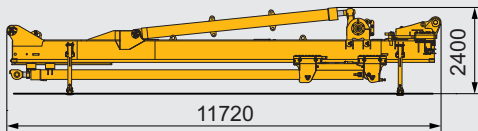

Base machine

G = 51.0 t
B = 3,380 mm

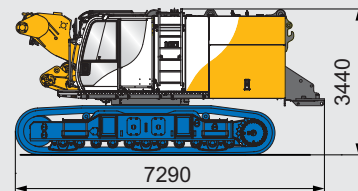

Mast extension (optional)

G = 2.0 t
B = 900 mm

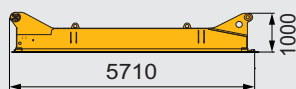

Counterweight

G = 6 x 4.9 t
B = 3,000 mm





Global Network



Service



Equipment



Training

International Service Hotline

+800 1000 1200* (freecall)

+49 8252 97-2888

BMA-Service@bauer.de

* Where available



BAUER Maschinen GmbH
 BAUER-Strasse 1
 86529 Schrobenhausen
 Germany
 Tel.: +49 8252 97-0
bma@bauer.de
www.bauer.de

Design developments and process improvements may require the specification and materials to be updated and changed without prior notice or liability. Illustrations may include optional equipment and not show all possible configurations. These and the technical data are provided as indicative information only, with any errors and misprints reserved.