

# BAUER

# Trench Cutter Systems

*BC System*





## BAUER Trench Cutters

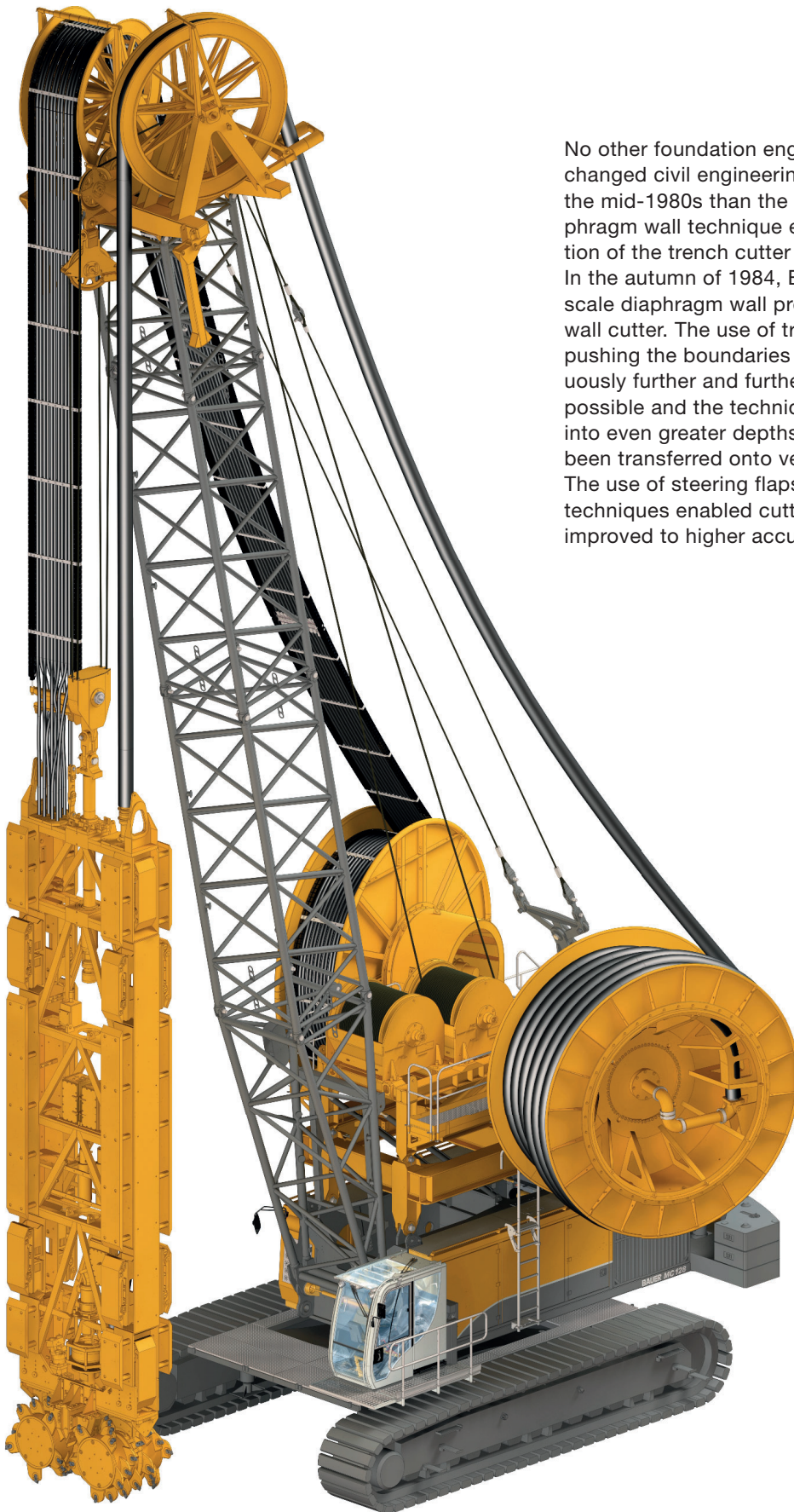

No other foundation engineering process has changed civil engineering more significantly since the mid-1980s than the development of the diaphragm wall technique especially with the introduction of the trench cutter technology. In the autumn of 1984, Bauer began the first large-scale diaphragm wall project with its own diaphragm wall cutter. The use of trench cutters resulted in pushing the boundaries of this technique continuously further and further. Thicker walls became possible and the technique was able to advance into even greater depths after the long hoses had been transferred onto vertically mounted hose reels. The use of steering flaps and advanced measuring techniques enabled cutter verticality to be steadily improved to higher accuracy.

## Development of the Cutter Technology



**First Bauer cutter**  
1984 BC 30 cut-off wall  
at Brombach reservoir

### Cutter technology for special applications



since 2004  
CSM Soil  
mixing  
*Here: Side  
cutter, 2012*

### Special construction to customer's specifications



BC 40  
Singapore,  
2012

### BC cutters on special base carriers



BC 30 Low  
Headroom,  
Paris, 2018

### BC cutters on standard base carriers



BC 48  
cut-off wall,  
Forgensee,  
Rosshaupten,  
2019

### Customized cutter systems for special projects



BC 50 with  
HDS 250,  
Saskatoon,  
Canada, 2019



The construction of diaphragm walls is a standard specialist foundation engineering technique. It covers a wide range of different applications in almost all kinds of geotechnical conditions. It provides various solutions for load bearing (reinforced in situ concrete wall, barrettes) and sealing purposes (cut-off walls).

A continuous wall is formed by a series of individual rectangular panels. During the excavation, the open trench is stabilized by a supporting fluid (e.g. thixotropic slurry). Depending on the wall type, the construction process differs after reaching the final excavation depth.

As the trend shows an increase of excavation depth in the future, the cutter system provides an economical and technically approved solution.

## Types of wall

- **Reinforced in-situ concrete walls (two-phase system)**  
After finishing the excavation of the panel, a reinforcement cage is lowered into the open panel and concrete is placed in the trench. By using the tremie method segregation of the concrete is prevented. As the concrete fills the trench from the bottom up, it displaces the lighter support fluid. The fluid is pumped out from the top of the trench, cleaned and recycled for reuse as support slurry for a new panel.
- **Cut-off walls constructed by the two-phase process**  
For sealing purposes using a two-phase cut-off wall, a placement of a reinforcement cage is not necessary. The support fluid is subsequently cleaned and then replaced in a second phase by the actual barrier material (e.g. plastic concrete) which is placed in the trench using the tremie method.
- **Cut-off walls constructed by the single-phase process**  
In this process the support fluid, which is pumped into the trench during the excavation stage, consists of a bentonite-cement slurry that remains in the trench after completion of the excavation and forms a self-hardening barrier inside the trench. The placement of a reinforcement cage is not necessary.
- **Cutter Soil Mixing variant**  
During application of the Cutter Soil Mixing process, the soil material is first loosened during penetration of the cutter and continuously mixed with a self-hardening slurry. The result is a mixed rectangular element of soil and cement. If necessary, steel beams can be installed afterwards. (For further details of this process see our brochure 905.656.2)

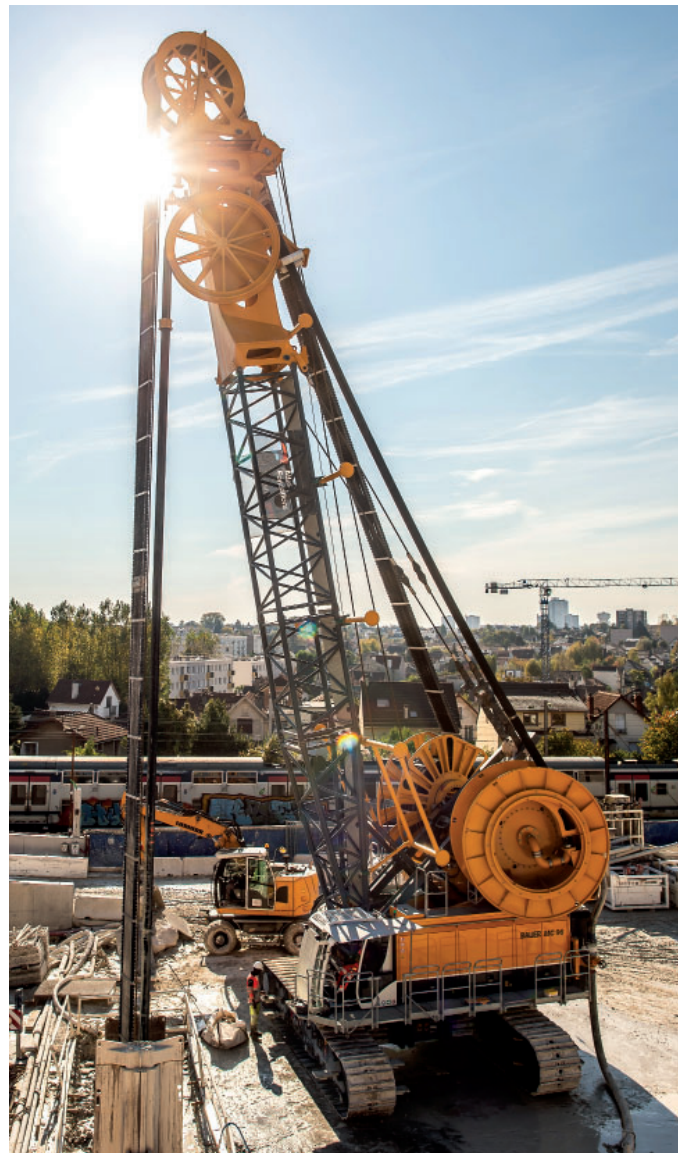



## Diaphragm wall applications

The range of available cutter systems is now so varied and technically advanced that diaphragm walls can provide structurally sound and cost-effective solutions for the most diverse construction projects even in restricted site conditions, at great depths and in hard soil formations.

**Inner-city deep excavation retaining walls** are used for the construction of underground car parks, underground stations, shaft walls, relocation of roads or railway lines underground, etc. Depending on their wall thickness, concrete quality and proportion of steel reinforcement, diaphragm walls used as retaining walls provide very stiff, low-deformation and watertight walls. They can bear high horizontal and vertical loads resulting from earth pressure, hydrostatic pressure, building and traffic loads. They can be used either as temporary or permanent construction elements.



**Underground sealing walls (cut-off walls)** are utilized e.g. for water retaining structures or encapsulation of contaminated areas. This application reduces or eliminates seepage. Water tightness, plasticity and erosion resistance are important criteria for the wall as a product. Ideally, the base of a cut-off wall should be keyed into an underlying impermeable soil or rock formation (clay layer, bedrock).



## Main components and operating principle

The centerpiece of the system, the actual BAUER trench cutter, consists of a **steel frame** with two **gearboxes** attached at its base. In operation they rotate in opposite direction around a horizontal axis. **Cutter wheels** suitable for the prevailing ground conditions are mounted on the gearboxes. Due to the rotation of these cutter wheels, the soil material below the cutter is continually loosened, broken down and conveyed towards the suction inlet of the mud pump. To enable the gearboxes to absorb the impact forces generated by breaking up larger stones or cobbles without being damaged, they are protected by shock absorbers mounted between cutter wheels and gearbox.

A hydraulically operated centrifugal **mud pump** is mounted just above the cutter wheels. The mud pump continuously conveys the slurry, charged with soil material and cuttings, to the surface and then to the treatment plant. In loose soil

formations and when using high viscous slurries (e.g. single phase system) the capacity of the mud pump is crucial for the excavation output. The gearbox and the mud pump are protected against damaging ingress of e.g. bentonite slurry by a **pressure compensation system**.

The performance and output of a cutter is critically dependent on: the crowd force signified by the cutter weight, and the torque delivered by the cutter wheels. Both factors mutually influence each other. In order to achieve optimum excavation outputs, BAUER trench cutter systems are provided with a particularly sensitive electronically operated **crowd winch** for controlling the crowd pressure. Depending on the strength of the soil, the control parameters used are either the cutter's speed of penetration (in light soils) or the surcharge on the cutter wheels (in hard soils).

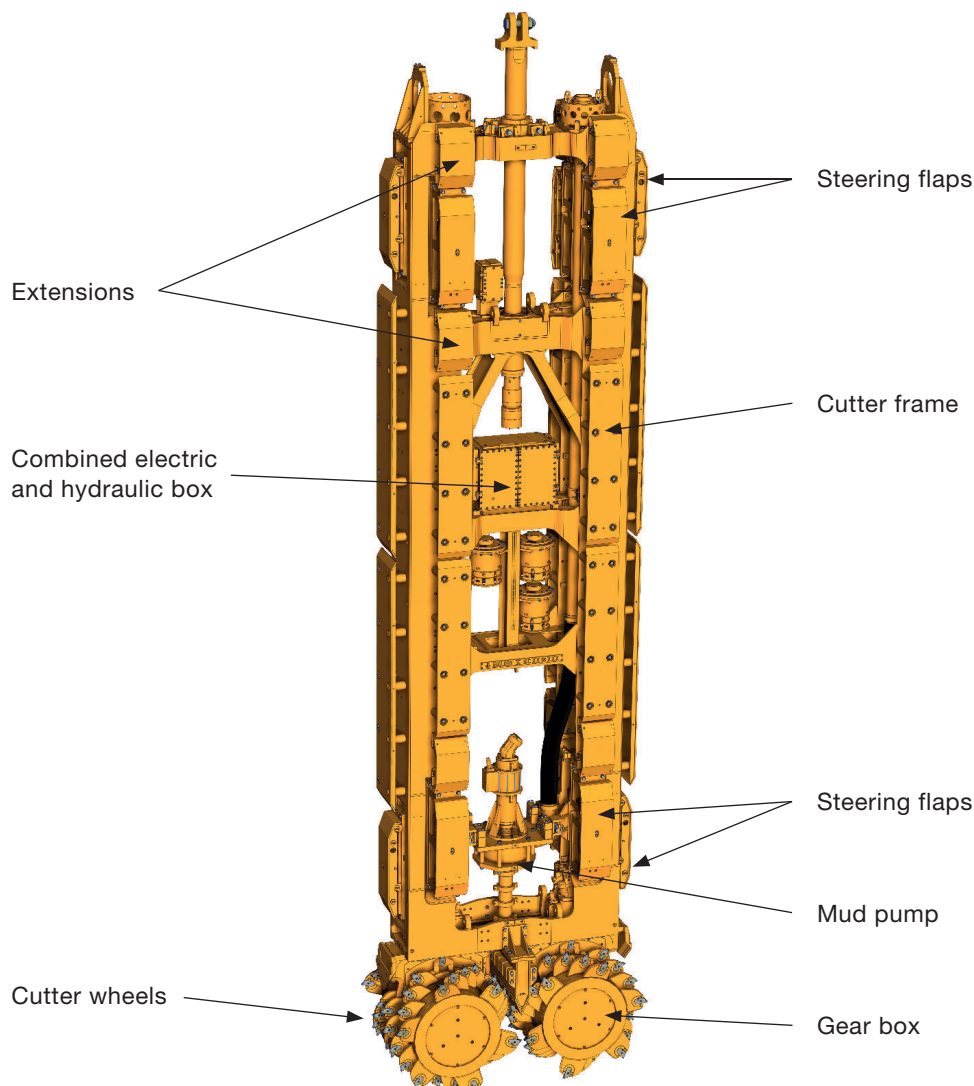



# Cutting Wheels

Cutter progress is heavily dependent on the soil conditions, so the selection of the most suitable type of cutter wheels is essential. On all BAUER trench cutters the ridge forming below the shields, is cut by a flap tooth. BAUER cutter wheels are available in a variety of sizes to enable cutting of different widths of trenches. Additionally the suction box and the cutter frame have to be adapted to the required trench width.

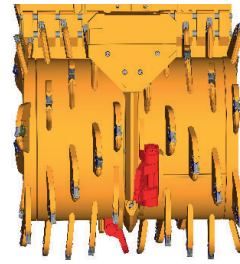

Flap tooth

## Standard Applications



### Standard cutter wheel

Standard cutter wheels are primarily used in mixed soils. They are equipped with a large number of differently shaped tungsten carbide-tipped teeth. A selection of different cutter teeth for various ground conditions is available. Long teeth holders enable easy replacement. Reamer plates, attached to the suction box, remove any spoil between the tooth holders, particularly in cohesive soils.



### Round shank chisel cutter wheel

Primarily designed for cutting cemented sands, conglomerates, cobbles and weathered rock, these cutter wheels are equipped with special round shank chisels. The teeth arrangement on the wheel in combination with the flap teeth ensures cutting of the whole cross-section area to enable constant cutting progress even in hard formations.

## Special Applications

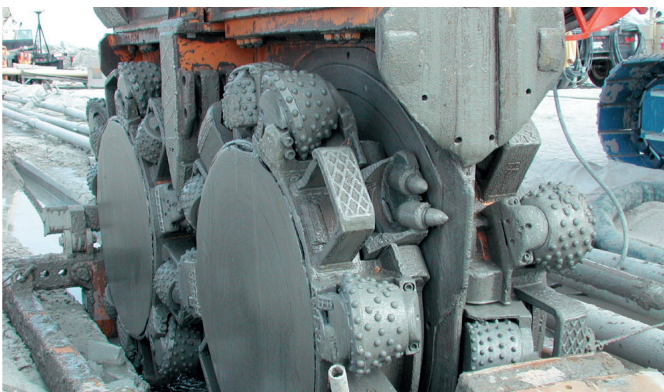

### Roller bit cutter wheel

The roller bit cutter wheel has been developed for extremely hard rock formations (UCS > 120 MPa). The roller bit arrangement on the wheel ensures cutting of the whole cross-section area. The higher necessary loads for the roller bits are generated by additional ballast mounted on the cutter frame.



### Hybrid cutter wheel

The hybrid cutter wheel is equipped with a combination of round shank chisels, flat teeth and reamer plates in a regular pattern. Its main use is cutting through non-cohesive or cohesive overburden soil followed by socketing into hard soil or rock.

# Cutter Types

MBC 30

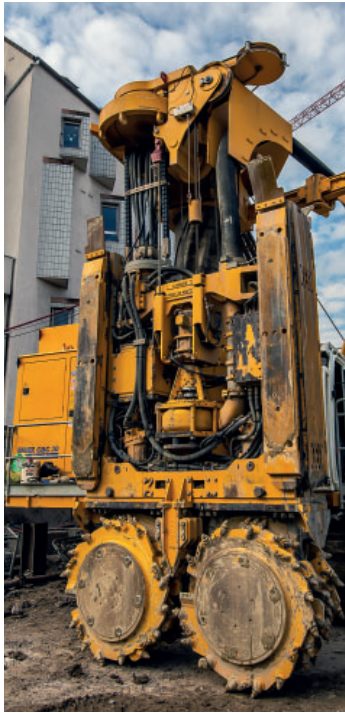

BC 32



BC 35

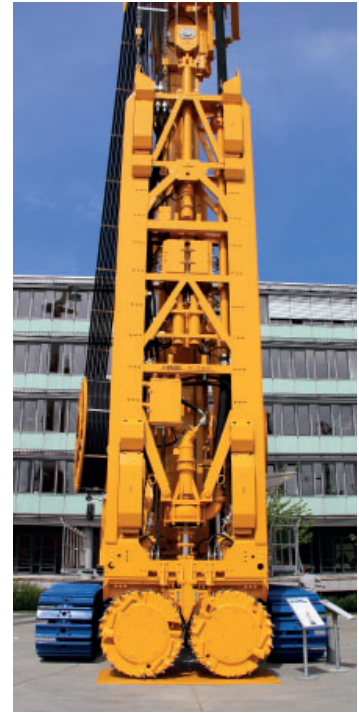

Standard gearbox	2 x BCF 9	2 x BCF 9	2 x BCF 9
Torque max.	91 kNm	91 kNm	91 kNm
Speed of rotation	0 – 25 rpm	0 – 25 rpm	0 – 25 rpm
Cutter length	2,800 mm	2,800 / 3,200 mm	2,800 / 3,200 mm
Cutter width	640 – 1,500 mm	640 – 1,500 mm	640 – 1,500 mm
Overall height	4.5 m	9.3 m	12.6 m
Max. delivery rate of mud pump	450 m <sup>3</sup> /h	450 m <sup>3</sup> /h	450 m <sup>3</sup> /h
Dia. of mud pipe	5" / 6"	6"	6"
Weight (hook load)	20.2 – 28.7 t	25.6 – 34 t	31.1 – 39.2 t



BC 40



BC 48



BC 50



Standard gearbox	2 x BCF 10	2 x BCF 11	2 x BCF 12
Torque max.	100 kNm	112 kNm	120 kNm
Speed of rotation	0 – 25 rpm	0 – 25 rpm	0 – 25 rpm
Cutter length	2,800 – 3,200 mm	2,800 – 3,200 mm	2,800 – 3,200 mm
Cutter width	800 – 1,800 mm	800 – 2,000 mm	1,200 – 2,000 mm
Overall height	12.6 m	12.6 m	12.7 m
Max. delivery rate of mud pump	450 m <sup>3</sup> /h	450 m <sup>3</sup> /h	450 m <sup>3</sup> /h (opt. 2 x)
Dia. of mud pipe	6"	6"	6"
Weight (hook load)	36.1 – 50.1 t	33.9 – 52.7 t	45.5 – 70.0 t

## Advantages Cutter System

### Applicability in all soil conditions

Various types of cutter wheels and the use of a “flap tooth” system enable Bauer trench cutters to be deployed in all types of soil including socketing the wall into hard rock formations.

\* Shown values are based on experience and not legally binding.

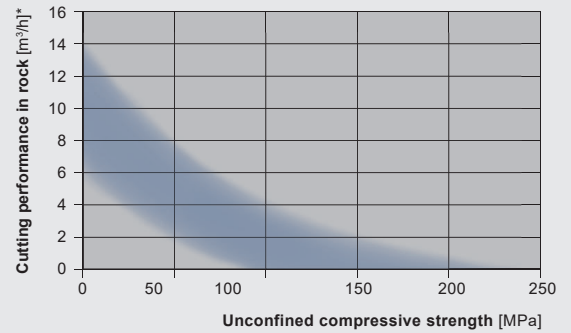

### Reliable joint construction

The overcut joint describes a watertight interlocking of adjacent panels. Primary panels are partially re-cut at their edges during excavation of the intermediate (secondary) panel. This system has nearly no limitations in depth. The cutter system can optionally also be combined with alternative joint systems, which are limited in depth.

### Low noise and vibration emission

The excavation of trenches in the immediate vicinity of sensitive buildings and structures is possible.



### Easy spoil handling

The closed bentonite slurry circulation ensures the continuous working process of the system. Due to the removal of solid particles from the support fluid in the mud treatment plant, the excavated material can simply be moved off site from a centralized area. After the separation the slurry is available for reuse within the system.



## Advantages BAUER Cutter Systems



### Excellent trench verticality

is ensured by the design of the cutter with its elongated steel cutter frame and by carrying out continuous real-time inclination measurements (B-Tronic) throughout the excavation process. The inclination of the cutter frame can be corrected continually by a computer-controlled steering plate system

### Great experience

Over 35 years in experience allows Bauer to provide site specific support. Customer benefit from support by the method technique department during planning and construction stage.

To guarantee professional handling skills of your personnel, Bauer trains and supports your staff on site (e.g. operator and mechanic trainings, support during assembling and commissioning)



### Single source solution

Bauer provides all necessary components for the cutter system. It includes cutter, base carrier, slurry handling equipment and spare parts. The components are complimentary to each other and ensure high performance. In addition Bauer provides an easy and reliable provision of spare parts and equipment components.

### Customized solutions and ongoing innovations

For high demanding jobs (e.g. great depth, challenging ground conditions and confined working environments) Bauer offers customized solutions by using well proven and tested components.

With ongoing innovation we also get you prepared for the future. Increasing demand for reducing emissions, environmental impact and also new methods and technologies requires a strong partner with state of the art technology and leading innovations.

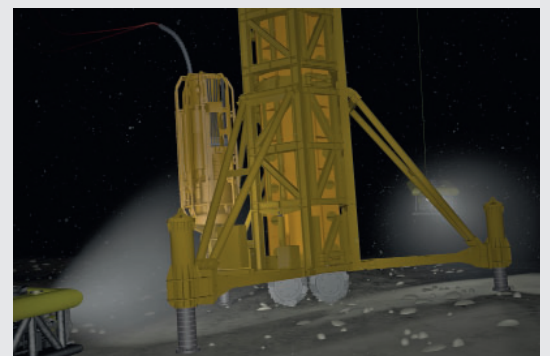

## B-Tronic

The B-Tronic system developed by Bauer Maschinen is an integrated system for controlling all cutter operations and visualizing actual operating parameters in real-time on a large interactive touchscreen monitor. The following operating parameters are displayed:

- Actual cutter depth
- Speed of rotation and hydraulic oil pressure of each cutter gearbox
- Delivery volume of mud pump
- Crowd pressure on cutter teeth
- Penetration rate
- Inclination of trench cutter and computed deviations in x- and y-axis (digital and graphic)
- Internal gearbox pressure
- Gearbox temperature
- Residual pull on crowd winch (surcharge)

In addition to these basic operational data, general machine operating parameters (e.g. engine data) are also recorded and monitored. The display of current machine operating parameters and error messages is a valuable aid for targeted and effective fault diagnostics by service personnel on site, but also by specialists based at our main factory or in subsidiaries.

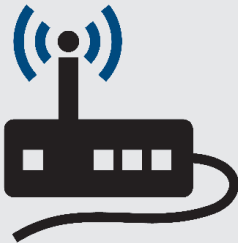
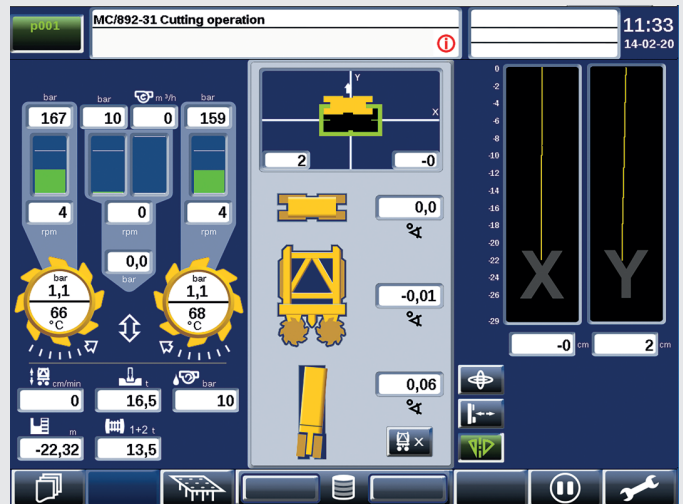

## DTR Module

The DTR module establishes an internet connection and allows to exchange data between machine and WEB-BGM system. Via WEB BGM the equipment and production data can be accessed by the client and the Bauer customer service team. Remote assistance can be provided to the client in case error messages appear on the operator's screen.

## Verticality control

An inclinometer, which is integrated into the main cutter frame, measures the inclination of the cutter frame continually in both x- and y-axis. Throughout the cutting process, the inclinations are continuously displayed in degrees on the operator's screen.

A gyroscope can also be fitted to measure the rotation of the trench cutter about its vertical axis.

If the cutter deviates from its vertical direction, then the position of the cutter can be adjusted in longitudinal and transverse direction of the trench with 12 individually controlled steering flaps.

Deviations in longitudinal direction of the trench axis can be further corrected by adjusting the rotation speed of the cutter wheels.

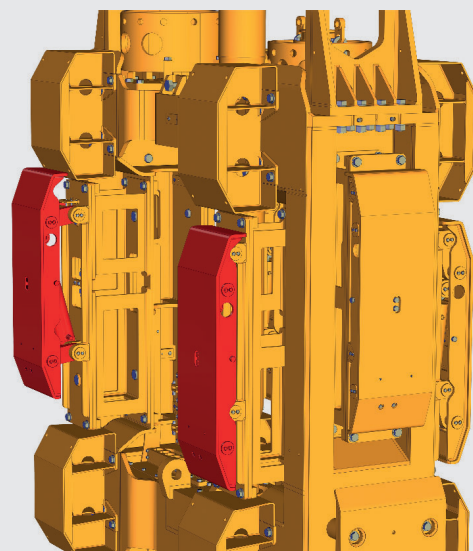



## Rotation Device

The cutter is generally aligned perpendicular to the upper carriage of the base machine. For the construction of corner wall panels for excavation pits or when operating on narrow embankments, the cutter has to be rotated and aligned with the base machine.

### Rotation device for cutter systems equipped with HDS, HSS

For cutter systems equipped with drag chain hose carriers, the cutter frame is rotated in the trench relative to the hose carrier. The maximum rotation angle is dependent on the trench width and amounts to around 20° for a trench width of 1,000 mm.

### Rotation device for cutter systems on crawler crane MC 96 with hose drum system (HDS-T)

With the hose drum system HDS-T greater depths (>70 m) can be reached with the cutter in a rotated position. The rotation of the BC cutter is realized through an attachment on the boom head and a special type of pulley block which allow rotating the cutter steplessly from - 50° to + 95°.

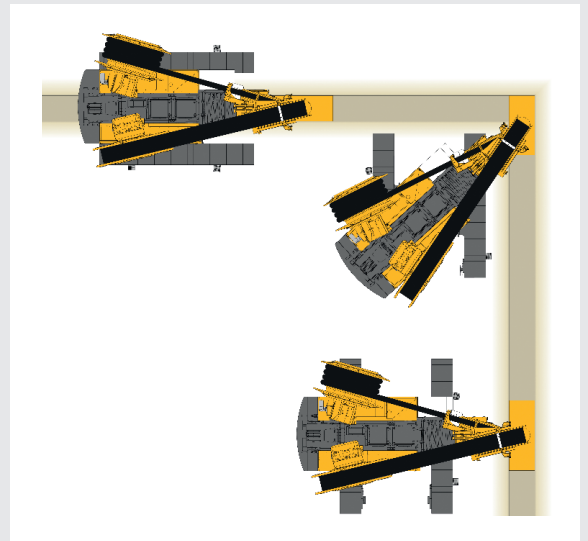

### Rotation device for cutter systems equipped with a single hose guide wheel system (HTS)

For cutter systems equipped with a HTS system, rotation of the hoses is achieved by parallelogram frames mounted at the boom head and the base of the boom.

With this device the cutter can be rotated by up to 90°.

Additional foldable hose guide rollers attached at the guide wall can guide the hoses into the center of the trench.

# Hose Handling Systems

Both the mud hose and the hydraulic hoses must follow the cutter into the trench under constant tension. The original system of hose guide wheels and constant tension winches becomes uneconomical for greater trench depths, due to the length of the boom and the correspondingly heavy base machine. For deep trenches and for the construction of trenches in confined areas, the hoses can be coiled up. The hydraulic hoses – and for greater depths also the mud hoses – can be carried in special drag chain hose carriers for strain relief.

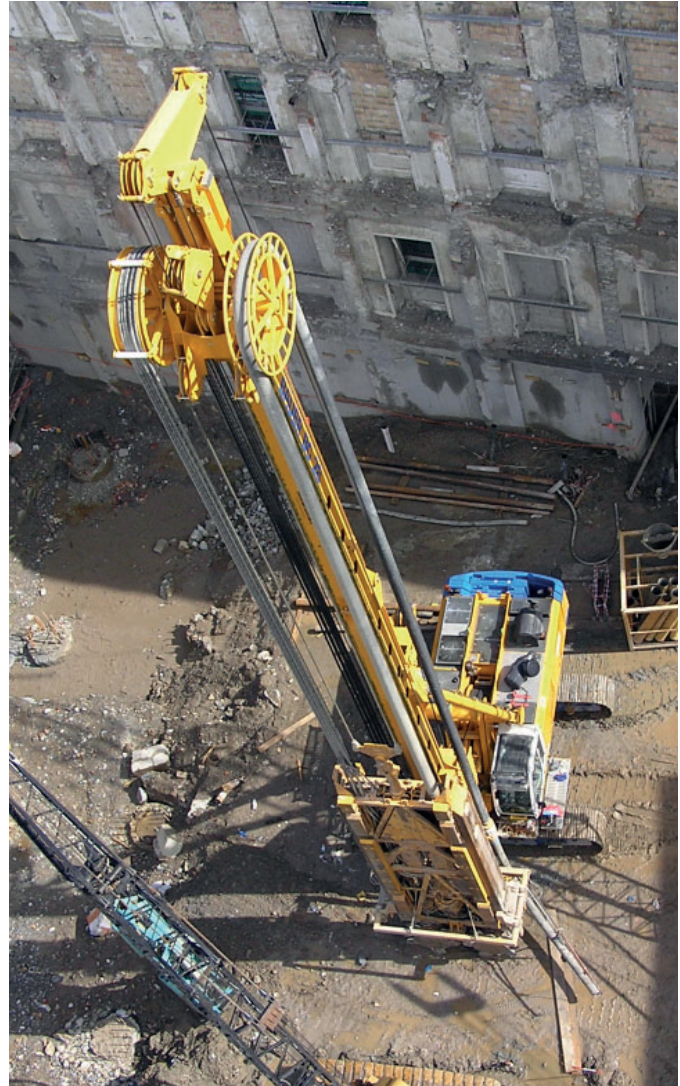

## HTS (Hose tensioning system)

The mud hose and the hydraulic hoses are lowered into the trench by guide wheels. The guide wheels are suspended on constant-tension winches which keep the hoses uniformly tensioned. The achievable cutter depth is equivalent to twice the available travel of the guide wheels. The required capacity of the base machine is determined by the weight of the cutter and the height of the boom.

## HSS (Hose synchronization system)

The HSS hose synchronization system is used when the cutter is mounted on a BG drilling rig. The guide wheels for the mud hose, the hydraulic hoses and the hoist ropes for the cutter are mounted on a special sledge. The sledge is raised and lowered along the mast by the main hoist winch of the base machine. As a result of the uniform movement of the guide wheels, the vertical movement of the hoses and the hoist ropes is mechanically synchronized.



### **HDS (Hose drum system)**

Coiling mud and hydraulic hoses onto two large hydraulically operated hose drums reduces the boom height and thus the required capacity of the base machine. In addition, it leads to reduced dimensions of the entire unit. Systems for cutting depths up to 250 m have already been built. Specially modified systems can operate with the cutter in rotated position (HDS-T).





## Standard Carriers



### MC Duty-cycle cranes

The Bauer Duty-cycle cranes **MC 86**, **MC 96** and **MC 128** are ideal base machines for BC cutters. The entire hydraulic power supply of the attached cutter is provided by the hydraulic systems of the MC crawler cranes, which have been specially designed for these applications. The HTS hose guide system as well as the HDS hose drum system can easily be mounted on the MC crawler crane, as the upper carriage has been reinforced accordingly. (left)



### BG Rotary drilling rigs

Mounting a cutter on a BG rotary drilling rig is a relatively new concept. This system is suitable for mid-range cutting depths up to 48 m (depending on BG rig type). The hydraulic power supply for the cutter is provided by the appropriately designed hydraulic system of the BG base machine. An important selection criterion for this equipment combination is the low space requirement of the unit. When mounting a cutter on a BG rotary drilling rig the HSS hose synchronization system is used. By mounting an HDS hose drum system on the upper carriage of a BG base machine, cutting depths of up to 100 m can be realized. (right)



## Special Carriers

### CBC 30

The CBC 30 “SilentCutter” is specially designed for low headroom applications. It is mounted on the cutter base machine MT 130 designed exclusively for this type of application. In combination with the HD 1400 and the HDS hose drum system, it ensures a high degree of flexibility with regard to different set-up variants. The set-up variants allow the operation in extremely confined construction site conditions and requirements. A special tunnel set-up is also available.



### CBC 45

The CBC 45 “SilentCutter” is a further improvement of former CBC systems. The CBC 45 can be equipped with the established BAUER trench cutters BC 35 and BC 40. The hose handling system HDS (Hose Drum System) facilitates a cutting depth of 100 m. One of the characteristic features is the low noise emission of the new hydraulic power pack HD 1400. The unit is mounted on a special carrier with longitudinally arranged hydraulic power pack. The CBC 45 unit is especially developed for constricted urban site conditions.

# Trench Cutter Systems – Typical Combinations

## Attachment to Crawler Crane or BG –

hose drum system (HDS)



**BG 45 BS 95 BC HDS 100**

**MC 96 BC 35 HDS 100 T**

Height	21 – 27 m
Cutting depth	80 – 250 m
Installed power	433 – 709 kW
Turning device	On request

## Attachment to BG –

hose synchronizing system (HSS)

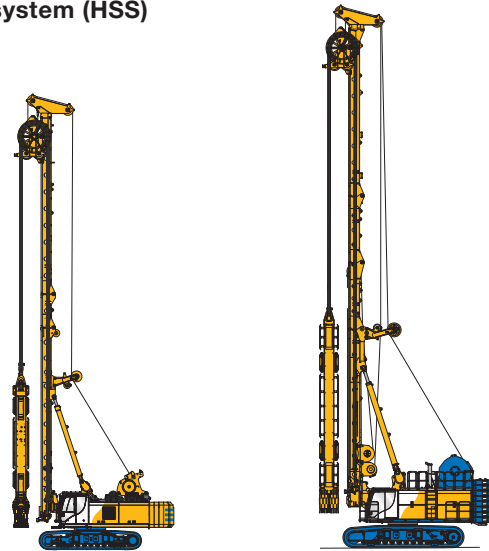

**BG 30 BS 80 BCS 40**

**BG 46 BS 115 BC 40 HSS**

Height	25 – 32 m
Cutting depth	36 – 48 m
Installed power	354 – 433 kW
Turning device	not possible



## Attachment to Crawler Crane –

hose tensioning system (HTS)



MC 86 BC 35 70

MC 128 BC 40 HTS

Height	28 – 45 m
Cutting depth	38 – 70 m
Installed power	570 – 709 kW
Turning device	On request



## Special Units

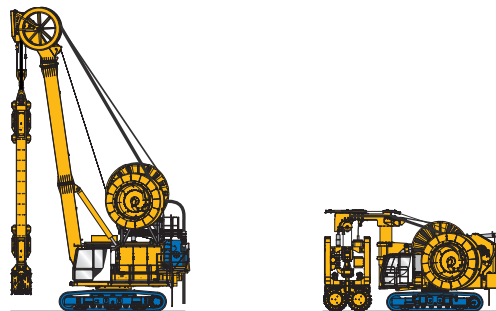

CBC 45

CBC 30 Low-headroom

Height	18 m	(5) – 6 m
Cutting depth	80 – 120 m	60 – 80 m
Installed power	563 kW (HD 1400)	563 kW (HD 1400)
Turning device	not possible	yes



## Trench Cutter Systems – Typical Combinations

	MBC30		BC 32			BC 35		
		HTS	HDS	HSS	HTS	HDS	HSS	
MC 64 / MC 86	○	■	▲		■	■		
MC 96	○	■	▲		■	■		
MC 128		▲	▲		■	■		
MT 120 (BS 80 BB)				■				
BG 28 (BS 80) / BG 30 (BS 95)				■				
BG 33 (BT 85)				○			○	
BG 45 (BS 95)			▲	○		■	○	
BG 55 (BS 115)			▲			■		
CBC 30 (MT 130)	■							
CBC 45 (MT 160)			▲	▲		■		

○ on request

▲ possible

■ recommended





	BC 40			BC 48			BC 50		
	HTS	HDS	HSS	HTS	HDS	HSS	HTS	HDS	HSS
MC 64 / MC 86	■	■		■	■				
MC 96	■	■		■	■			■	
MC 128	■	■		■	■		■	■	
MT 120 (BS 80 BB)									
BG 28 (BS 80) / BG 30 (BS 95)									
BG 33 (BT 85)									
BG 45 (BS 95)		■	○		■	○			
BG 55 (BS 115)		■			■				
CBC 30 (MT 130)									
CBC 45 (MT 160)		■			■				

○ on request

▲ possible

■ recommended





# Slurry Treatment Systems

During the construction of a diaphragm wall the open trench is stabilized and supported by bentonite slurry. When a trench cutter is deployed, the slurry also takes on the role of conveying the excavated soil material to the surface. The charged slurry is pumped to a desanding plant. There, the solid particles are separated from the slurry and the

cleaned support fluid is pumped back into the trench. Mixing and desanding units, desilters and decanters, as well as pumps required for slurry treatment are delivered by Bauer-MAT Slurry Handling Systems. (also refer to brochure "Product Range" 905.779.1+2)







### Desanding

BAUER desanding plants are developed specifically for use with trench cutters. They are characterized by the following features:

- Modular set-up of the entire plant in order to adapt the treatment capacity to soil type and cutter performance.
- Secondary treatment circuits with desilters or centrifuge possible
- Quick set-up and dismantling Containerized transport dimensions

Costs for the environmentally-friendly disposal of slurries are continuously increasing.

**By using decanters** fine particles are separated from slurries. In combination with flocking agents a complete separation of solids and water is possible.

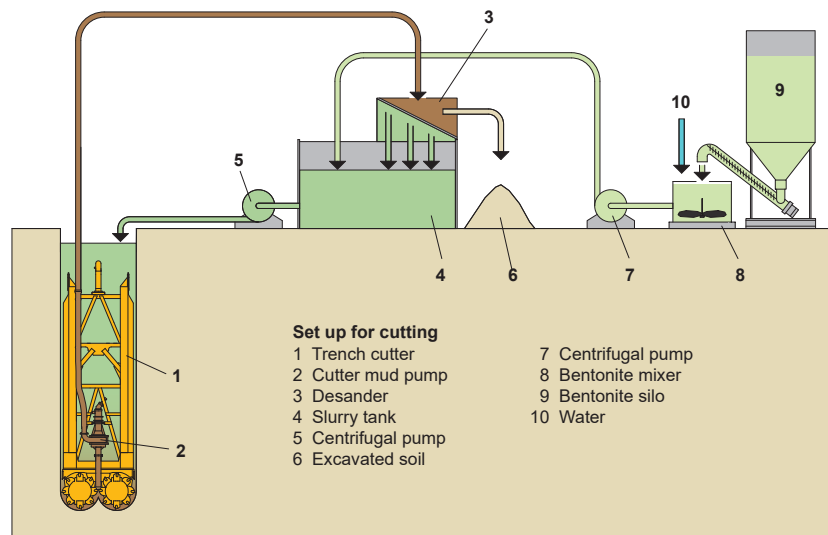

### Pumping

#### KBKT

High-capacity pumps developed by Bauer are used to ensure the recirculation of cleaned slurry into the trench. These pumps can also be deployed as “booster” pumps whenever slurries have to be pumped over longer distances.





*BC System*



**BAUER Maschinen GmbH**  
**BAUER-Strasse 1**  
**86529 Schrobenhausen**  
**Germany**  
**Tel. +49 8252 97-0**  
**bma@bauer.de**  
**www.bauer.de**

Design developments and process improvements may require the specification and materials to be updated and changed without prior notice or liability. Illustrations may include optional equipment and not show all possible configurations. These and the technical data are provided as indicative information only, with any errors and misprints reserved.